

# PERIMETER CHANNEL

*Beginning as a companion part to Stella's structural glass walls, the labour-saving details of our perimeter channels have led to their popularity as a stand-alone glazing solution.*

*We now offer a complete family of perimeter channel systems to accommodate all your project needs.*

## PERIMETER CHANNEL ADVANTAGES

- Thermal break for **increased thermal performance**
- **Dry-glaze install** using wedge gasket (no need for silicone) results in:
  - Fast install
  - No wait for silicone to dry
  - Ease of glass replacement
  - Accommodation of building movement (silicone can stretch and tear)
- **Easy connection** - via joint connector hardware
- **DIY or fully-fabricated** – supplied in 3.65m [12'] lengths or cut to length
- **Versatile**
  - Base and side mounted options
  - Suitable for all types of structural walls (and more)
  - Glaze from inside or outside
- **Support at the side** – These channels carry the weight of the glass enabling it to be stacked (without transferring loads to panel below or requiring additional hardware at wall jambs) (optional ledge add-on)

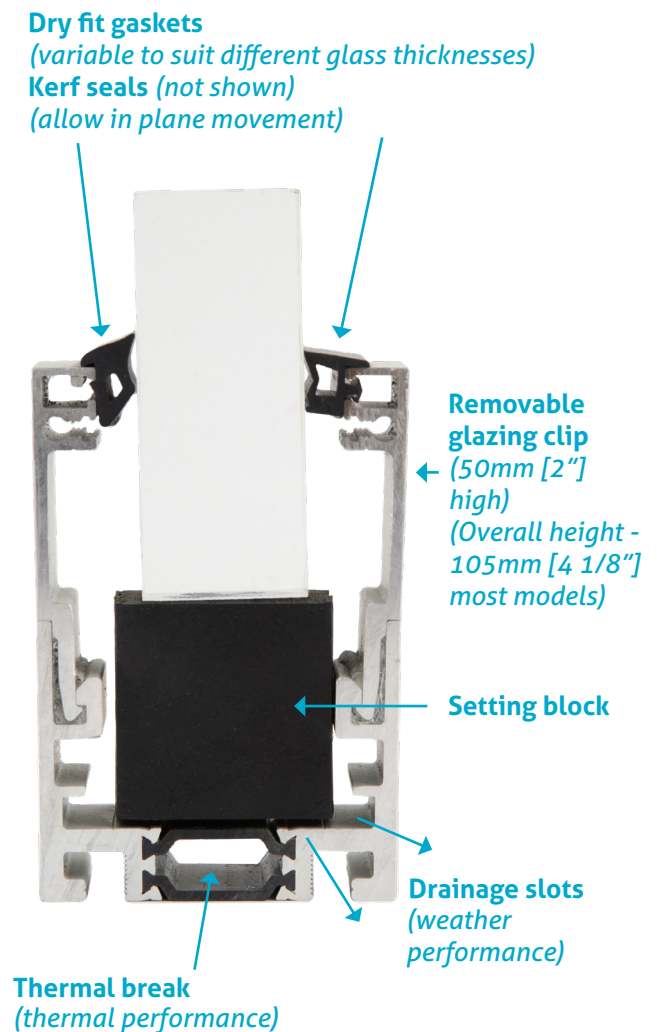

**For more information contact Stella Custom Glass Hardware**

# FEATURED PERIMETER CHANNEL DESIGN

## Long Leg Option

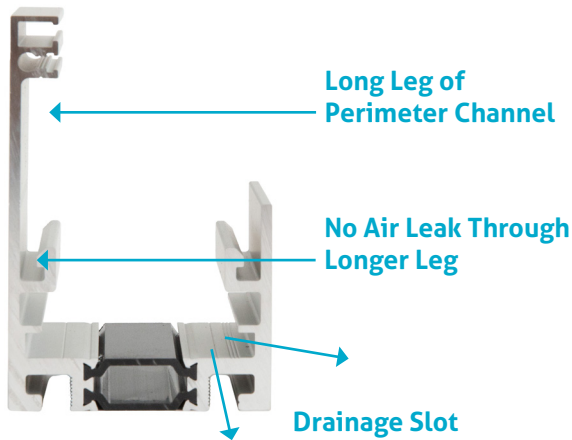

**Easier Install** – Fixed long leg stays in place during install, reducing labour hours.

*During typical perimeter channel install, glazing clips can fall into channel requiring second installer to be inside, propping up the clips.*

**Improved Envelope Performance** - Longer leg eliminates potential air leakage

**Glaze from Exterior or Interior**

**Handle with Care** - Prevent potential damage before installation by ensuring site is aware of this element

## MATERIAL INFO

Made of **6063-T5 aluminum**

- Lighter than steel
- Suitable for anodizing and painting

Finishes options include mill, anodized, painted, powder-coated, and brushed stainless steel cladding

## STELLA ADVANTAGES

		"Typical" Metal Break Shape	Stella Perimeter Channels
Applications	Non-point-supported glass walls	✓	✓
	Point-supported glass walls	✓	✓
	Internal walls	✓	✓
Advantages	Ease of install	—	✓
	Ease of glass replacement	—	✓
	Great thermal performance	—	✓
	Accommodates system movements	—	✓

## SYSTEM OPTIONS

Perimeter Channel Series	Glass Thickness	Standard Product	Thermally Broken	Base Mount Option	Side Mount Option	Glazing Clips Both Sides	Long Leg Option one side
PC2108	10 to 19mm [3/8" to 3/4"]	✓	—	✓	✓	—	✓
PC2110	10 to 21.5mm [3/8" to 7/8"]	✓	—	✓	✓	✓	✓
PC2910	25 to 29mm [1" to 1 1/8"]	—	✓	✓	✓ *	✓	✓
PC3710	25.5 to 37.5mm [1" to 1 1/2"]	✓	✓	✓	✓ *	✓	✓
PC4510	43.5 to 45.5mm [1 11/16" to 1 13/16"]	—	✓	✓	✓ *	✓	✓
PC5510	55mm [2 1/8]	—	✓	✓	✓ *	✓	✓
PC5711	55mm [2 1/8] <i>(Note – 115mm [4 1/2"] tall vs. all others at 100mm [4"]</i>	—	✓	✓	✓ *	—	✓

\* with support angle

# STANDARD DETAILS ASSEMBLY DRAWINGS

**NON-THERMALLY BROKEN**

**PC2110 Series**

*For Glass Thickness  
10 to 19mm [3/8" to 3/4"]*



REV.	DATE	DESCRIPTION	DRAWN BY	CHECKED BY
0	2013-09-04	Drawing Release	RL	
1	2021-02-17	Material Information Updated	VK	AS

ITEM	PART	DESCRIPTION	MATERIAL	FINISH	QTY.
1	PC-2110	PERIMETER CHANNELS SERIES	ALUMINUM 6063 - T6	CLEAR ANODIZED	-

**BOTTOM MOUNTED**

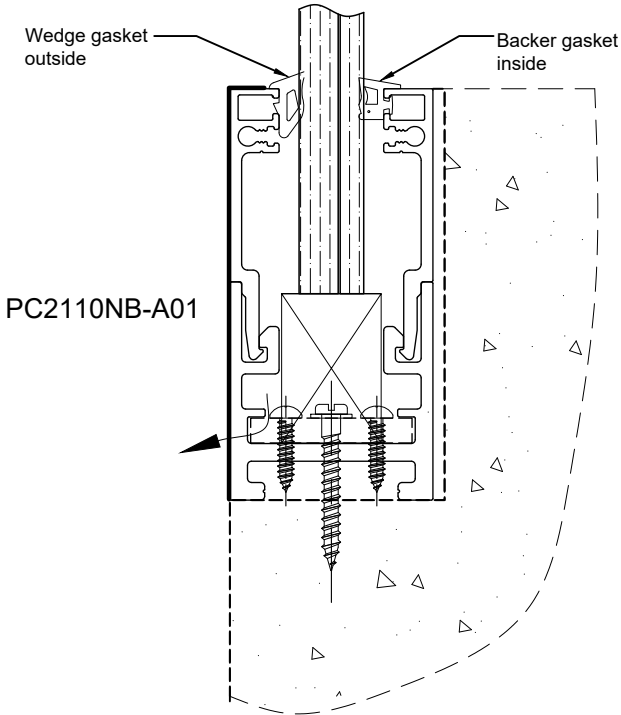

**FACE MOUNTED**

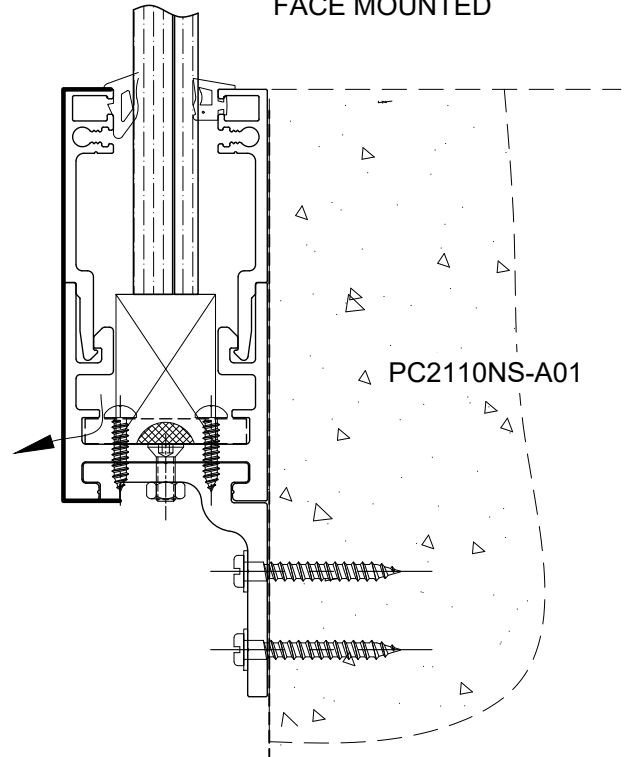

**SILL DETAILS**

**TOP MOUNTED**

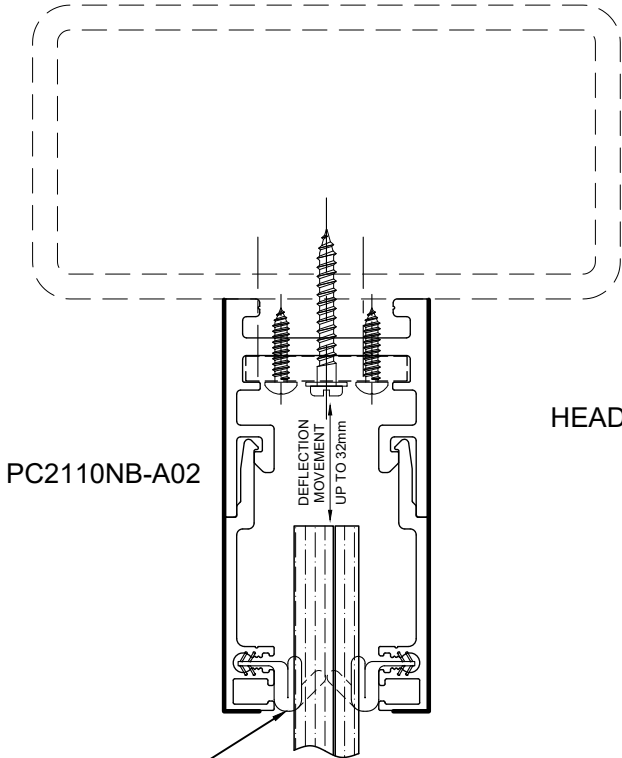

**FACE MOUNTED**

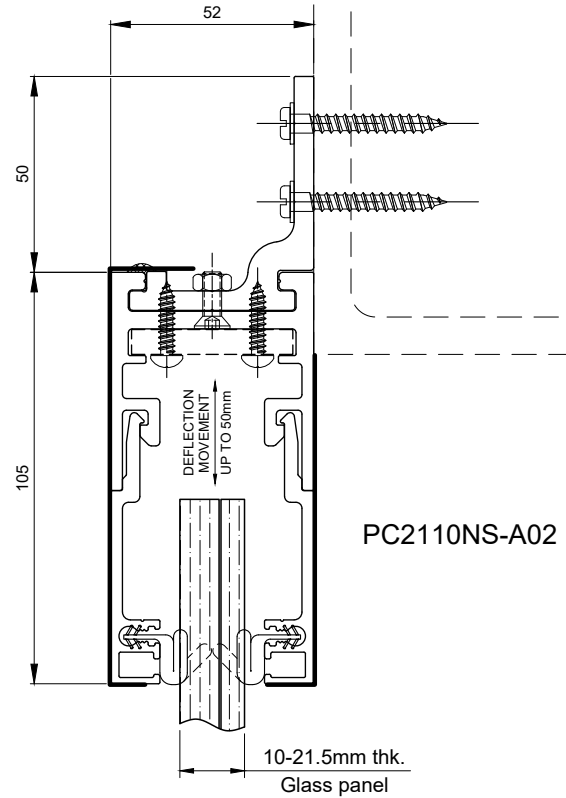

**HEAD DETAILS**

**Notes:**  
1. Other finishes available upon request

CUSTOMER APPROVAL  
SIGNATURE: \_\_\_\_\_  
DATE: \_\_\_\_\_

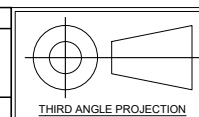

SCALE  
1:2  
DWG No  
PC-2110 SERIES



UNIT 105-8218 NORTH FRASER WAY, BURNABY, BC, V3N 0E9  
TEL (604) 231 5892 [WWW.STELLAGLASSHARDWARE.COM](http://WWW.STELLAGLASSHARDWARE.COM)

**PERIMETER CHANNELS**  
for MONOLITHIC OR LAMINATED GLASS UP TO 21.5mm THICK  
**PC-2110 SERIES**

REV.	DATE	DESCRIPTION	DRAWN BY	CHECKED BY
0	2013-09-04	Drawing Release	RL	
1	2021-02-17	Material Information Updated	VK	AS

ITEM	PART	DESCRIPTION	MATERIAL	FINISH	QTY.
1	PC2110NB-A01	PERIMETER CHANNEL - BOTTOM MOUNTED	ALUMINUM 6063 - T6	CLEAR ANODIZED	-

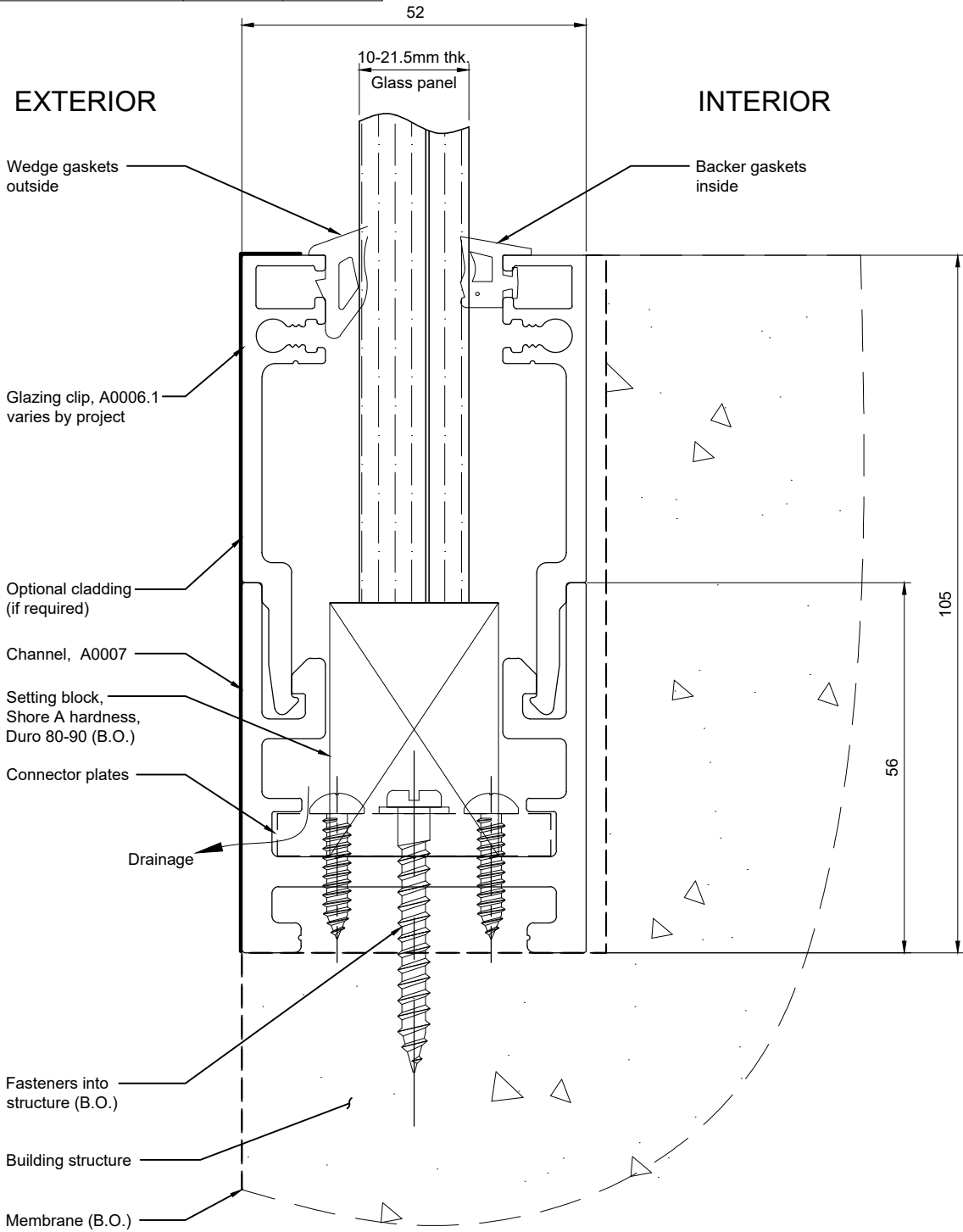

**SUBJECT TO CHANGE BY PROJECT**

**Notes:**

1. Other finishes available upon request

For Cast Part: Tolerances (ISO 8062-CT6), (mm) Unless Specified Otherwise									
NOM. DIMENSION	0 TO 10	10 TO 16	16 TO 25	25 TO 40	40 TO 63	63 TO 100	100 TO 160	160 TO 250	250 TO 400
TOLERANCE	±0.26	±0.27	±0.29	±0.32	±0.35	±0.39	±0.44	±0.50	±0.55
CASTING ANGLE TOLERANCE: ±0.5°									

CUSTOMER APPROVAL  
SIGNATURE:  
  
DATE:

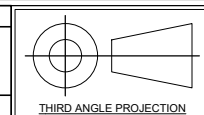

**PERIMETER CHANNEL  
for MONOLITHIC OR LAMINATED GLASS UP TO 21.5mm THICK  
SILL DETAIL - BOTTOM MOUNTED**

SCALE  
1:1  
DWG No  
PC2110NB-A01

UNIT 105-8218 NORTH FRASER WAY, BURNABY, BC, V3N 0E9  
TEL (604) 231 5892 [WWW.STELLAGLASSHARDWARE.COM](http://WWW.STELLAGLASSHARDWARE.COM)

REV.	DATE	DESCRIPTION	DRAWN BY	CHECKED BY
0	2013-09-04	Drawing Release	RL	
1	2021-02-17	Material Information Updated	VK	AS

ITEM	PART	DESCRIPTION	MATERIAL	FINISH	QTY.
1	PC-2110	PERIMETER CHANNELS SERIES	ALUMINUM 6063 - T6	CLEAR ANODIZED	-

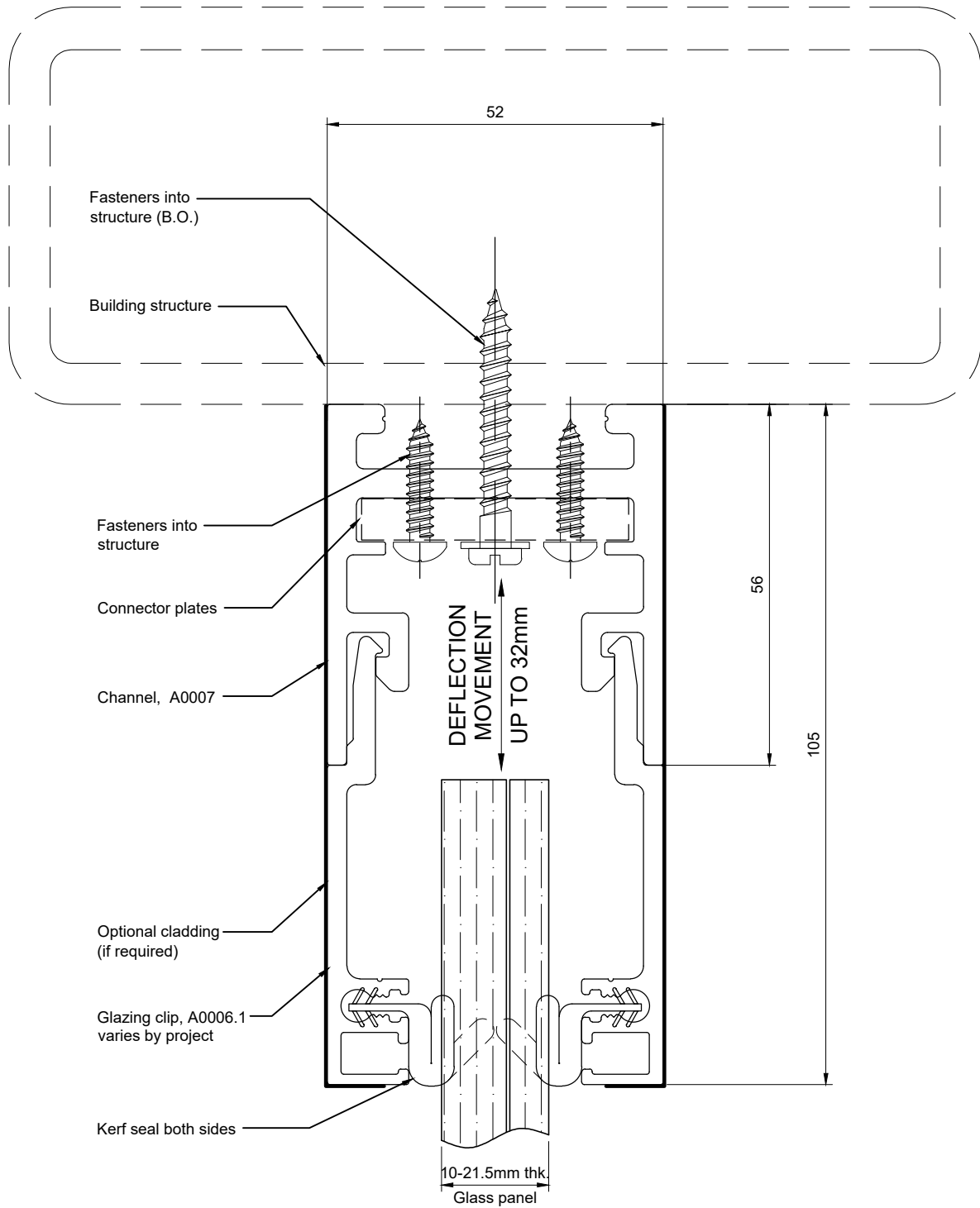

**SUBJECT TO CHANGE BY PROJECT**

**Notes:**

1. Other finishes available upon request

For Cast Part: Tolerances (ISO 8062-CT6), (mm) Unless Specified Otherwise									
NOM. DIMENSION	0 TO 10	10 TO 16	16 TO 25	25 TO 40	40 TO 63	63 TO 100	100 TO 160	160 TO 250	250 TO 400
TOLERANCE	±0.26	±0.27	±0.29	±0.32	±0.35	±0.39	±0.44	±0.50	±0.55
CASTING ANGLE TOLERANCE: ±0.5°									

CUSTOMER APPROVAL  
SIGNATURE:  
  
DATE:

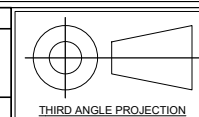

SCALE  
1:1  
DWG No  
PC-2110NB-A02



UNIT 105-8218 NORTH FRASER WAY, BURNABY, BC, V3N 0E9  
TEL (604) 231 5892 [WWW.STELLAGLASSHARDWARE.COM](http://WWW.STELLAGLASSHARDWARE.COM)

**PERIMETER CHANNEL**  
**for MONOLITHIC OR LAMINATED GLASS UP TO 21.5mm THICK**  
**HEAD DETAIL - TOP MOUNTED**

ITEM	PART	DESCRIPTION	MATERIAL	FINISH	QTY.
1	PC-2110NS-A01	PERIMETER CHANNEL - FACE MOUNTED	ALUMINUM 6063 - T6	CLEAR ANODIZED	-

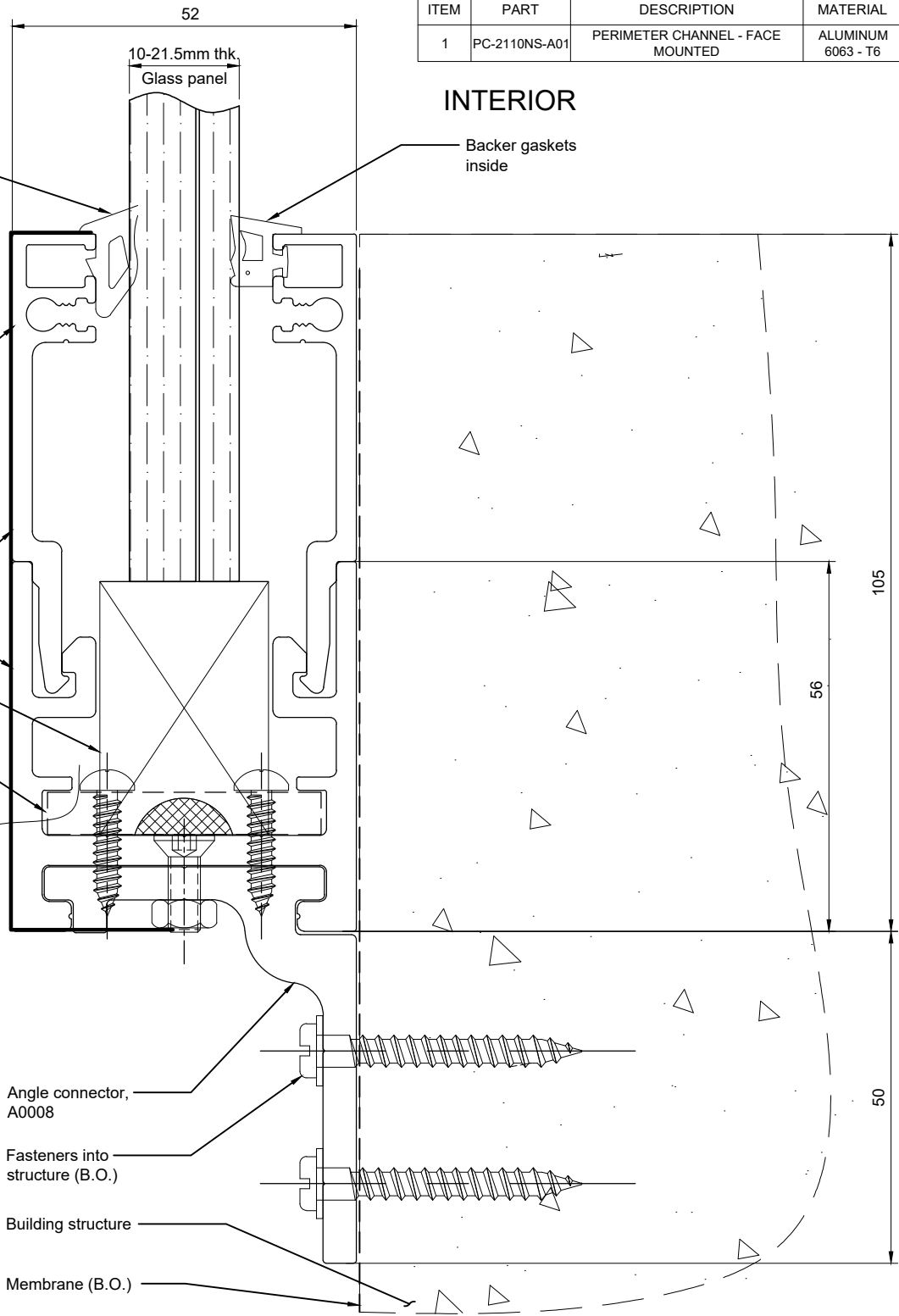

**SUBJECT TO CHANGE BY PROJECT**

**Notes:**

1. Other finishes available upon request

For Cast Part: Tolerances (ISO 8062-CT6), (mm) Unless Specified Otherwise

NOM. DIMENSION	0 TO 10	10 TO 16	16 TO 25	25 TO 40	40 TO 63	63 TO 100	100 TO 160	160 TO 250	250 TO 400
TOLERANCE	±0.26	±0.27	±0.29	±0.32	±0.35	±0.39	±0.44	±0.50	±0.55

CASTING ANGLE TOLERANCE: ±0.5°

REV.	DATE	DESCRIPTION	DRAWN BY	CHECKED BY
0	2013-09-04	Drawing Release	RL	
1	2021-02-17	Material Information Updated	VK	AS

CUSTOMER APPROVAL  
SIGNATURE:  
  
DATE:

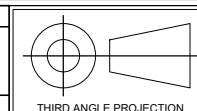

SCALE  
1:1  
DWG No  
PC-2110NS-A01

**stella**

UNIT 105-8218 NORTH FRASER WAY, BURNABY, BC, V3N 0E9  
TEL (604) 231 5892 [WWW.STELLAGLASSHARDWARE.COM](http://WWW.STELLAGLASSHARDWARE.COM)

**PERIMETER CHANNEL  
for MONOLITHIC OR LAMINATED GLASS UP TO 21.5mm THICK  
SILL DETAIL - FACE MOUNTED**

REV.	DATE	DESCRIPTION	DRAWN BY	CHECKED BY
0	2013-09-04	Drawing Release	RL	
1	2021-02-17	Material Information Updated	VK	AS

ITEM	PART	DESCRIPTION	MATERIAL	FINISH	QTY.
1	PC-2110	PERIMETER CHANNELS SERIES	ALUMINUM 6063 - T6	CLEAR ANODIZED	-

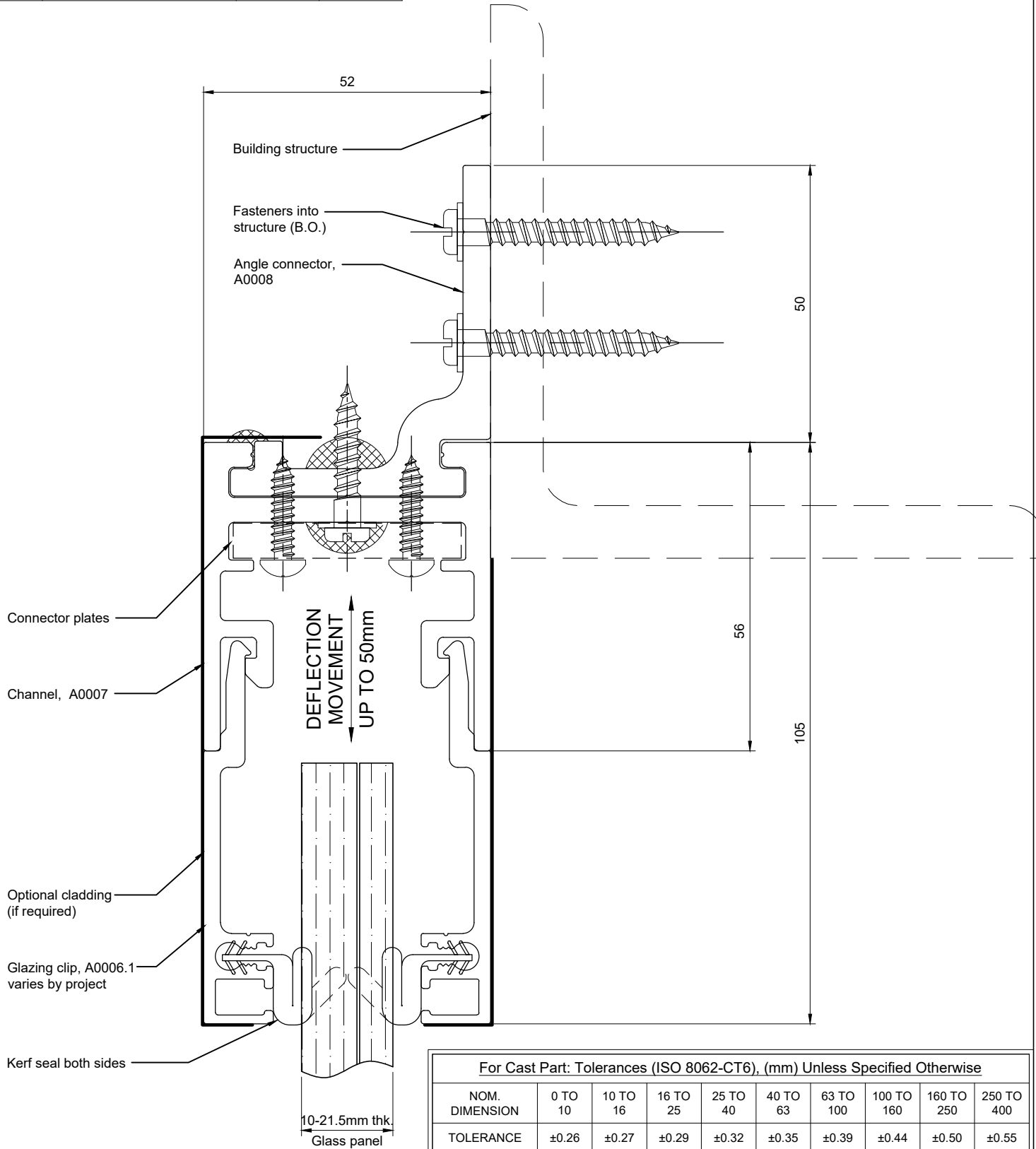

For Cast Part: Tolerances (ISO 8062-CT6), (mm) Unless Specified Otherwise									
NOM. DIMENSION	0 TO 10	10 TO 16	16 TO 25	25 TO 40	40 TO 63	63 TO 100	100 TO 160	160 TO 250	250 TO 400
TOLERANCE	±0.26	±0.27	±0.29	±0.32	±0.35	±0.39	±0.44	±0.50	±0.55
CASTING ANGLE TOLERANCE: ±0.5°									

**SUBJECT TO CHANGE BY PROJECT**

**Notes:**

- 1. Other finishes available upon request

CUSTOMER APPROVAL  
SIGNATURE: \_\_\_\_\_  
DATE: \_\_\_\_\_

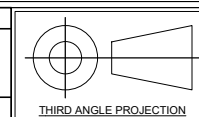

SCALE  
1:1  
DWG No  
PC-2110NS-A02



UNIT 105-8218 NORTH FRASER WAY, BURNABY, BC, V3N 0E9  
TEL (604) 231 5892 [WWW.STELLAGLASSHARDWARE.COM](http://WWW.STELLAGLASSHARDWARE.COM)

**PERIMETER CHANNEL**  
for MONOLITHIC OR LAMINATED GLASS UP TO 21.5mm THICK  
**HEAD DETAIL - FACE MOUNTED**



# STANDARD DETAILS ASSEMBLY DRAWINGS

**THERMALLY BROKEN**

**PC3710 Series**

*For Glass Thickness  
25.5 to 37.5mm [1" to 1 1/2"]*



REV.	DATE	DESCRIPTION	DRAWN BY	CHECKED BY
1	2020-09-15	INITIAL RELEASE	VK	AS

ITEM	PART	DESCRIPTION	MATERIAL	FINISH	QTY.
1	PC-3710T S-A01	THERMALLY BROKEN PERIMETER CHANNELS - FACE MOUNTED	ALUMINUM 6063-T6	CLEAR ANODIZED	-

### Side Details

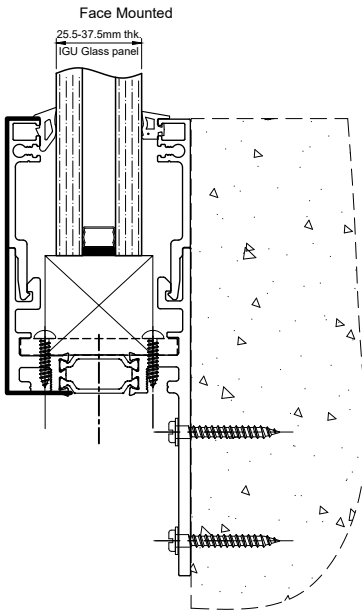

PC3710TS-A01

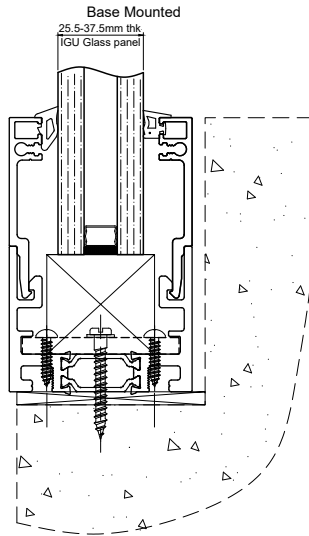

PC3710TB-A01

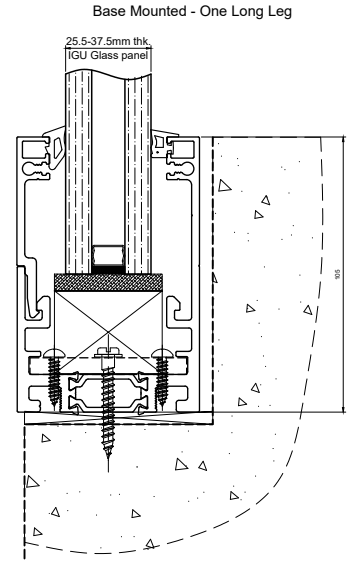

PC3710TB-A05

### Head Details

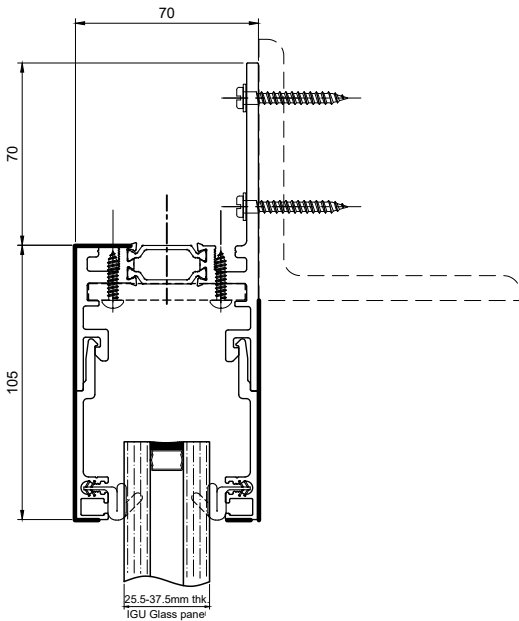

PC3710TS-A02

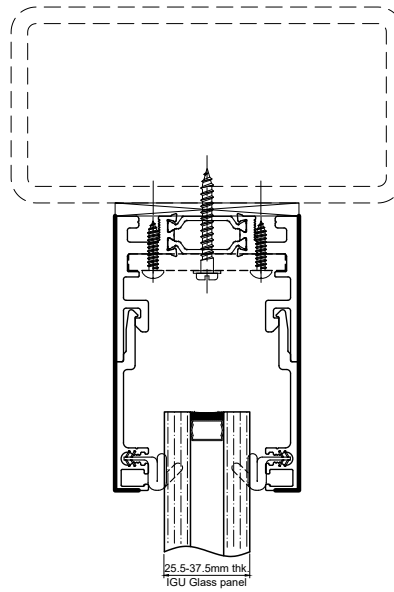

PC3710TB-A02

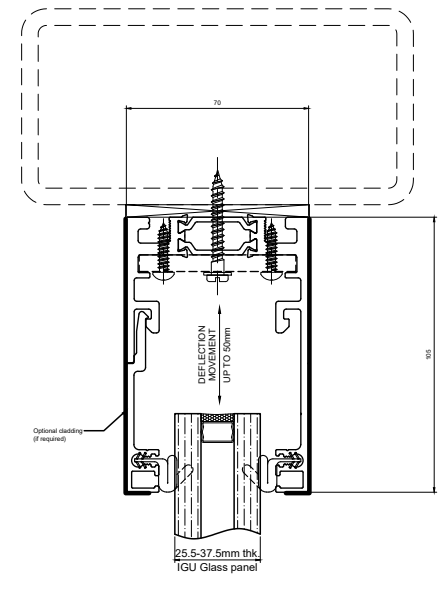

PC3710TB-A06

For Cast Part: Tolerances (ISO 8062-CT6), (mm) Unless Specified Otherwise

NOM. DIMENSION	0 TO 10	10 TO 16	16 TO 25	25 TO 40	40 TO 63	63 TO 100	100 TO 160	160 TO 250	250 TO 400
TOLERANCE	±0.26	±0.27	±0.29	±0.32	±0.35	±0.39	±0.44	±0.50	±0.55

CASTING ANGLE TOLERANCE: ±0.5°

**Notes:**

- 1. Other finishes available upon request

CUSTOMER APPROVAL

SIGNATURE:

DATE:

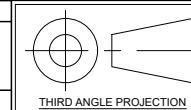

THIRD ANGLE PROJECTION

SCALE

1:3

DWG No

PC-3710 SERIES



UNIT 105-8218 NORTH FRASER WAY, BURNABY, BC, V3N 0E9  
TEL (604) 231 5892 [WWW.STELLAGLASSHARDWARE.COM](http://WWW.STELLAGLASSHARDWARE.COM)

THERMALLY BROKEN PERIMETER CHANNELS  
for SEALED GLASS UNITS UP TO 37.5mm THICK  
PC-3710 SERIES

REV.	DATE	DESCRIPTION	DRAWN BY	CHECKED BY
1	2014-04-07	INITIAL RELEASE	RL	RL
2	2021-02-17	FINISH INFORMATION UPDATED	VK	AS

ITEM	PART	DESCRIPTION	MATERIAL	FINISH	QTY.
1	PC3710TB-A01	THERMALLY BROKEN PERIMETER CHANNELS - BOTTOM MOUNTED	ALUMINUM 6063-T6	CLEAR ANODIZED	-

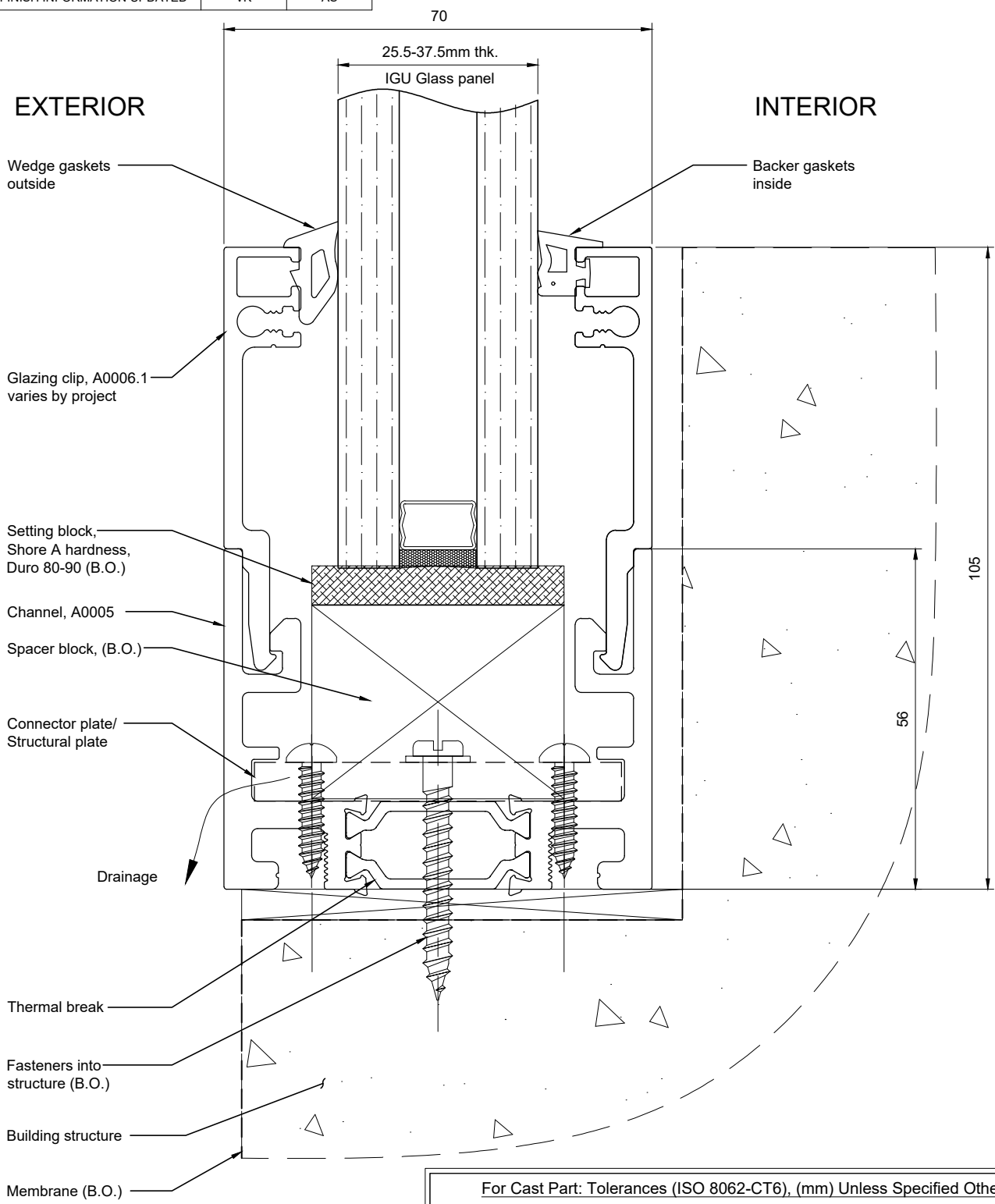

**SUBJECT TO CHANGE BY PROJECT**

**Notes:**  
1. Other finishes available upon request

For Cast Part: Tolerances (ISO 8062-CT6), (mm) Unless Specified Otherwise									
NOM. DIMENSION	0 TO 10	10 TO 16	16 TO 25	25 TO 40	40 TO 63	63 TO 100	100 TO 160	160 TO 250	250 TO 400
TOLERANCE	±0.26	±0.27	±0.29	±0.32	±0.35	±0.39	±0.44	±0.50	±0.55
CASTING ANGLE TOLERANCE: ±0.5°									

CUSTOMER APPROVAL  
SIGNATURE:  
  
DATE:

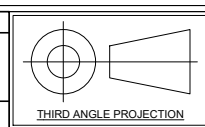

THERMALLY BROKEN PERIMETER CHANNELS  
for SEALED GLASS UNITS UP TO 37mm THICK  
SILL DETAIL - BOTTOM MOUNTED

SCALE  
1:1  
DWG No  
PC3710TB-A01

UNIT 105-8218 NORTH FRASER WAY, BURNABY, BC, V3N 0E9  
TEL (604) 231 5892 [WWW.STELLAGLASSHARDWARE.COM](http://WWW.STELLAGLASSHARDWARE.COM)

REV.	DATE	DESCRIPTION	DRAWN BY	CHECKED BY
1	2014-04-07	INITIAL RELEASE	RL	RL
2	2021-02-17	FINISH INFORMATION UPDATED	VK	AS

ITEM	PART	DESCRIPTION	MATERIAL	FINISH	QTY.
1	PC-3710T B-A02	THERMALLY BROKEN PERIMETER CHANNELS - TOP MOUNTED	ALUMINUM 6063-T6	CLEAR ANODIZED	-

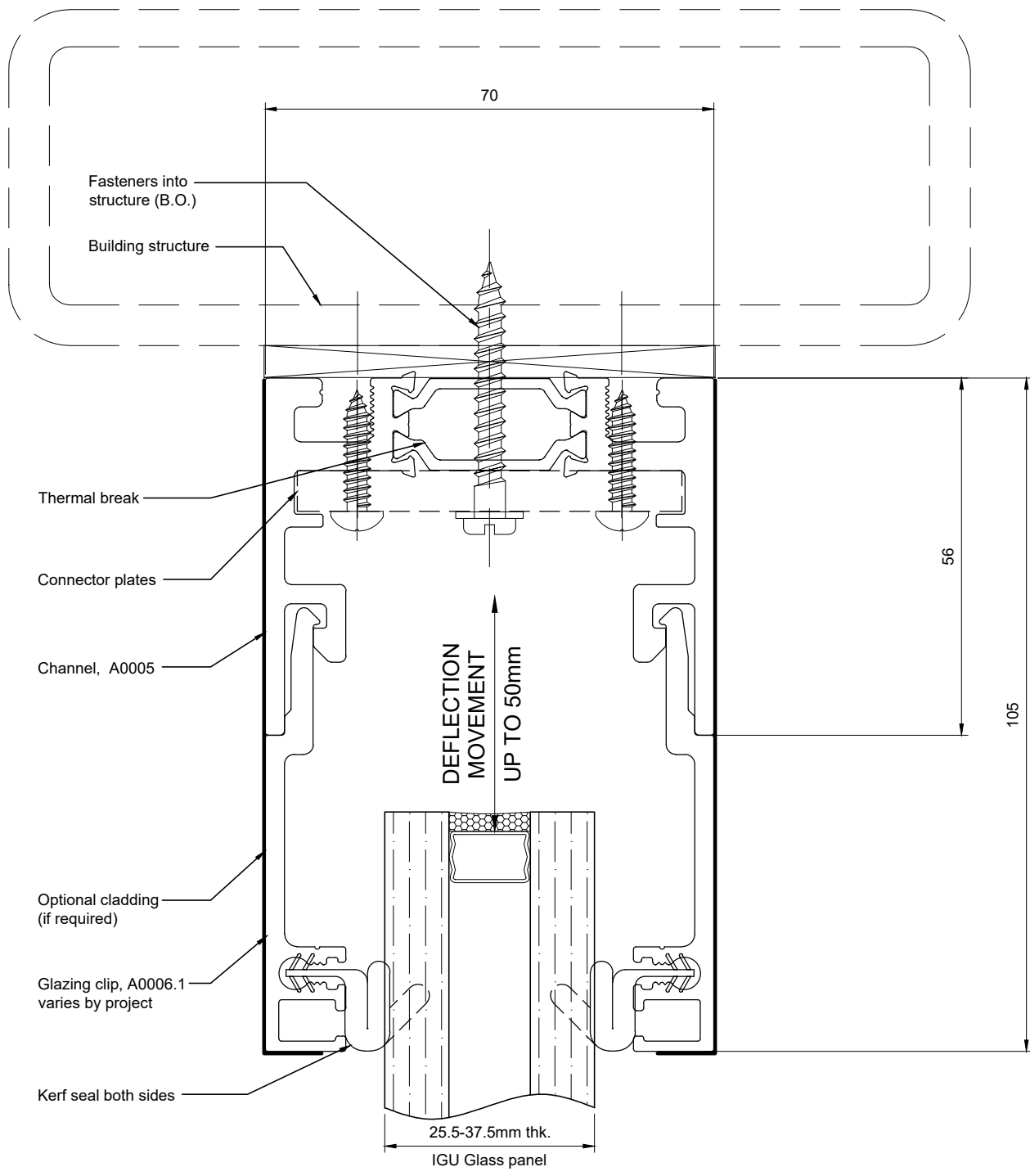

**SUBJECT TO CHANGE BY PROJECT**

**Notes:**  
1. Other finishes available upon request

For Cast Part: Tolerances (ISO 8062-CT6), (mm) Unless Specified Otherwise									
NOM. DIMENSION	0 TO 10	10 TO 16	16 TO 25	25 TO 40	40 TO 63	63 TO 100	100 TO 160	160 TO 250	250 TO 400
TOLERANCE	±0.26	±0.27	±0.29	±0.32	±0.35	±0.39	±0.44	±0.50	±0.55
CASTING ANGLE TOLERANCE: ±0.5°									

CUSTOMER APPROVAL  
SIGNATURE:  
  
DATE:

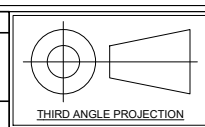

THERMALLY BROKEN PERIMETER CHANNELS  
for SEALED GLASS UNITS UP TO 37mm THICK  
HEAD DETAIL - TOP MOUNTED

SCALE  
1:1  
DWG No  
PC-3710TB-A02

UNIT 105-8218 NORTH FRASER WAY, BURNABY, BC, V3N 0E9  
TEL (604) 231 5892 [WWW.STELLAGLASSHARDWARE.COM](http://WWW.STELLAGLASSHARDWARE.COM)

REV.	DATE	DESCRIPTION	DRAWN BY	CHECKED BY
1	2014-04-07	INITIAL RELEASE	RL	RL
2	2021-02-17	FINISH INFORMATION UPDATED	VK	AS

ITEM	PART	DESCRIPTION	MATERIAL	FINISH	QTY.
1	PC3710TB-A05	THERMALLY BROKEN PERIMETER CHANNELS - BOTTOM MOUNTED - LONG LEG	ALUMINUM 6063-T6	CLEAR ANODIZED	-

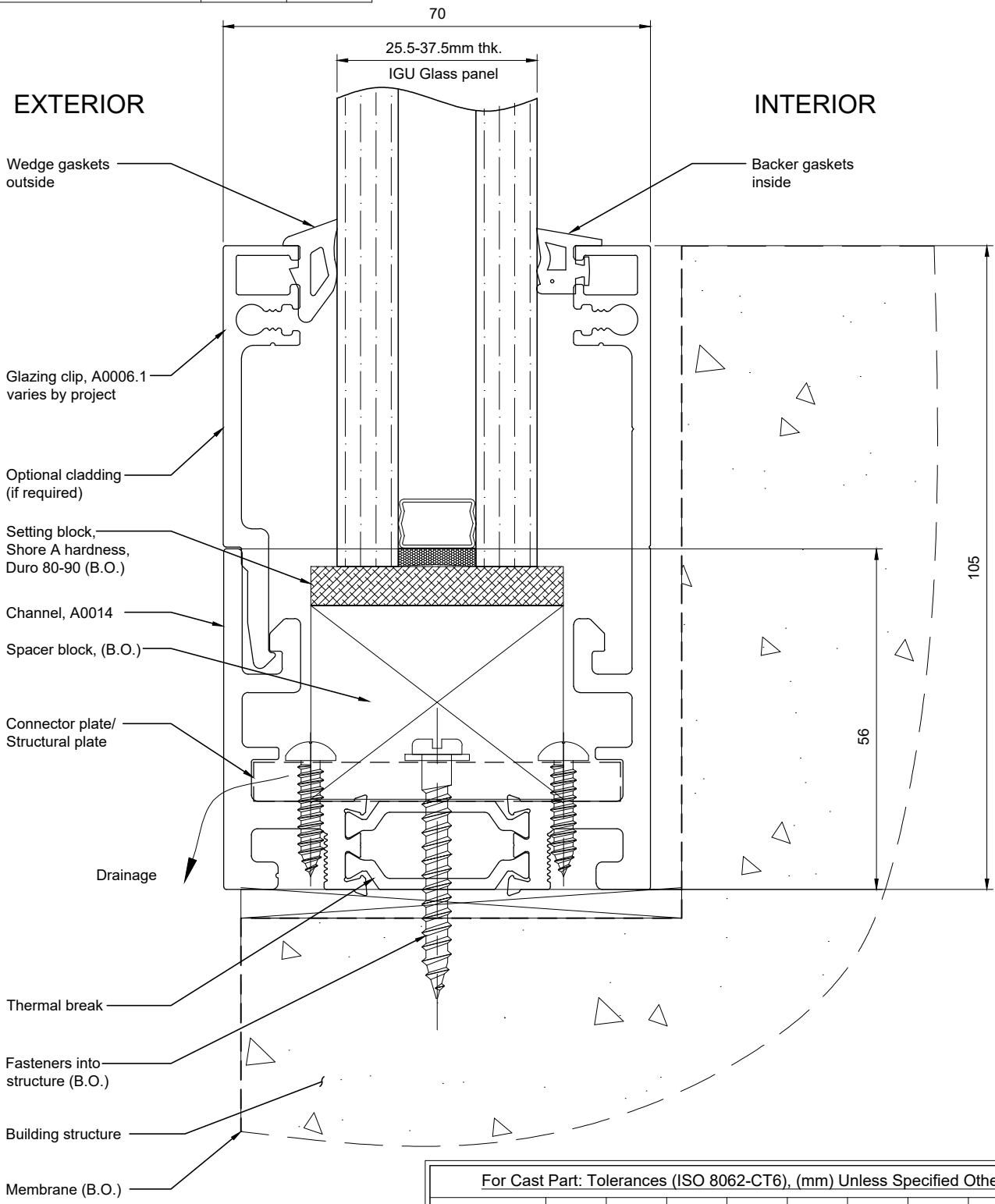

**SUBJECT TO CHANGE BY PROJECT**

**Notes:**  
1. Other finishes available upon request

For Cast Part: Tolerances (ISO 8062-CT6), (mm) Unless Specified Otherwise									
NOM. DIMENSION	0 TO 10	10 TO 16	16 TO 25	25 TO 40	40 TO 63	63 TO 100	100 TO 160	160 TO 250	250 TO 400
TOLERANCE	±0.26	±0.27	±0.29	±0.32	±0.35	±0.39	±0.44	±0.50	±0.55
CASTING ANGLE TOLERANCE: ±0.5°									

CUSTOMER APPROVAL  
SIGNATURE:  
  
DATE:

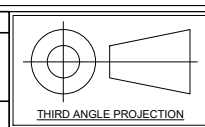

THERMALLY BROKEN PERIMETER CHANNELS  
for SEALED GLASS UNITS UP TO 37mm THICK  
SILL DETAIL - BOTTOM MOUNTED - LONG LEG

SCALE  
1:1  
DWG No  
PC3710TB-A05

UNIT 105-8218 NORTH FRASER WAY, BURNABY, BC, V3N 0E9  
TEL (604) 231 5892 [WWW.STELLAGLASSHARDWARE.COM](http://WWW.STELLAGLASSHARDWARE.COM)

REV.	DATE	DESCRIPTION	DRAWN BY	CHECKED BY
1	2014-04-07	INITIAL RELEASE	RL	RL
2	2021-02-17	FINISH INFORMATION UPDATED	VK	AS

ITEM	PART	DESCRIPTION	MATERIAL	FINISH	QTY.
1	PC-3710T B-A06	THERMALLY BROKEN PERIMETER CHANNELS - TOP MOUNTED - ONE LONG LEG	ALUMINUM 6063-T6	CLEAR ANODIZED	-

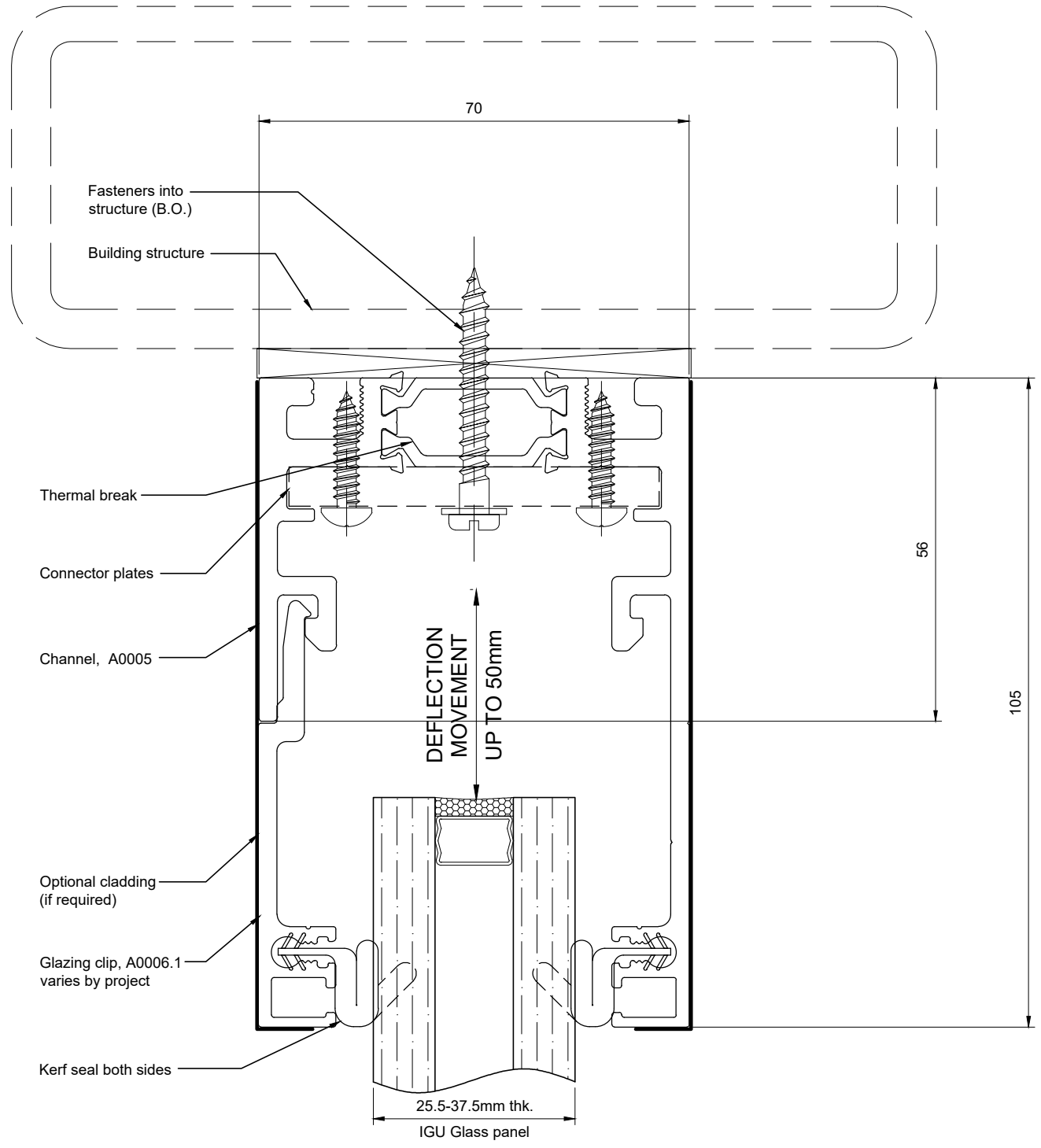

For Cast Part: Tolerances (ISO 8062-CT6), (mm) Unless Specified Otherwise									
NOM. DIMENSION	0 TO 10	10 TO 16	16 TO 25	25 TO 40	40 TO 63	63 TO 100	100 TO 160	160 TO 250	250 TO 400
TOLERANCE	±0.26	±0.27	±0.29	±0.32	±0.35	±0.39	±0.44	±0.50	±0.55
CASTING ANGLE TOLERANCE: ±0.5°									

**SUBJECT TO CHANGE BY PROJECT**

**Notes:**  
1. Other finishes available upon request

CUSTOMER APPROVAL  
SIGNATURE:  
  
DATE:

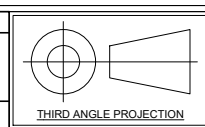

THERMALLY BROKEN PERIMETER CHANNELS  
for SEALED GLASS UNITS UP TO 37mm THICK  
HEAD DETAIL - TOP MOUNTED - ONE LONG LEG

SCALE  
1:1  
DWG No  
PC-3710TB-A06

UNIT 105-8218 NORTH FRASER WAY, BURNABY, BC, V3N 0E9  
TEL (604) 231 5892 [WWW.STELLAGLASSHARDWARE.COM](http://WWW.STELLAGLASSHARDWARE.COM)

ITEM	PART	DESCRIPTION	MATERIAL	FINISH	QTY.
1	PC-3710T S-A01	THERMALLY BROKEN PERIMETER CHANNELS - FACE MOUNTED	ALUMINUM 6063-T6	CLEAR ANODIZED	-

EXTERIOR

INTERIOR

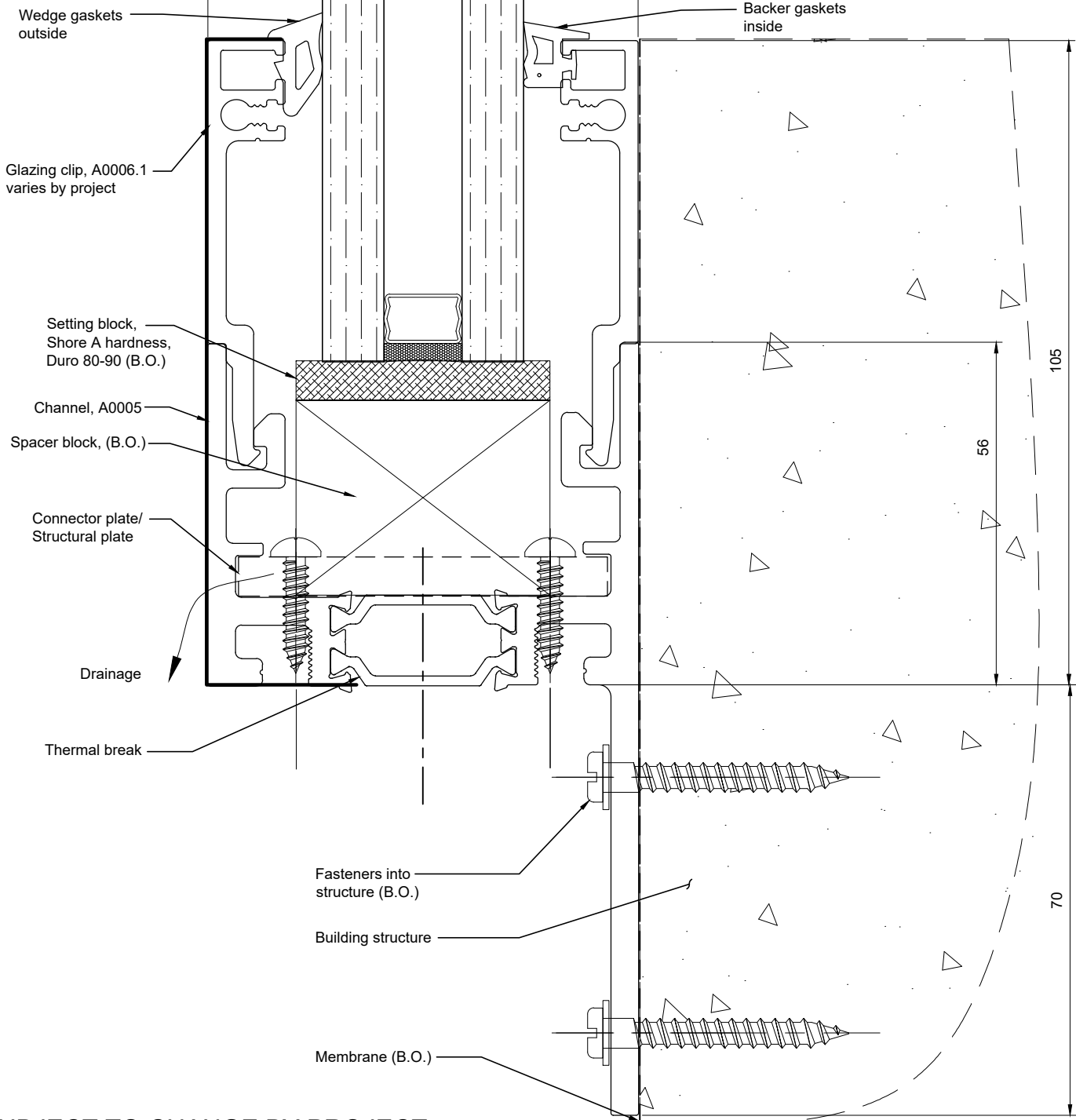

SUBJECT TO CHANGE BY PROJECT

**Notes:**

1. Other finishes available upon request

For Cast Part: Tolerances (ISO 8062-CT6), (mm) Unless Specified Otherwise

NOM. DIMENSION	0 TO 10	10 TO 16	16 TO 25	25 TO 40	40 TO 63	63 TO 100	100 TO 160	160 TO 250	250 TO 400
TOLERANCE	±0.26	±0.27	±0.29	±0.32	±0.35	±0.39	±0.44	±0.50	±0.55

CASTING ANGLE TOLERANCE: ±0.5°

REV.	DATE	DESCRIPTION	DRAWN BY	CHECKED BY
1	2014-04-07	INITIAL RELEASE	RL	RL
2	2021-02-17	FINISH INFORMATION UPDATED	VK	AS

CUSTOMER APPROVAL  
SIGNATURE:  
  
DATE:

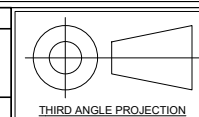

SCALE  
1:1  
DWG No  
PC-3710TS-A01



UNIT 105-8218 NORTH FRASER WAY, BURNABY, BC, V3N 0E9  
TEL (604) 231 5892 [WWW.STELLAGLASSHARDWARE.COM](http://WWW.STELLAGLASSHARDWARE.COM)

THERMALLY BROKEN PERIMETER CHANNELS  
for SEALED GLASS UNITS UP TO 37mm THICK  
SILL DETAIL - FACE MOUNTED

REV.	DATE	DESCRIPTION	DRAWN BY	CHECKED BY
1	2014-04-07	INITIAL RELEASE	RL	RL
2	2021-02-17	FINISH INFORMATION UPDATED	VK	AS

ITEM	PART	DESCRIPTION	MATERIAL	FINISH	QTY.
1	PC-3710T S-A02	THERMALLY BROKEN PERIMETER CHANNELS - FACE MOUNTED	ALUMINUM 6063-T6	CLEAR ANODIZED	-

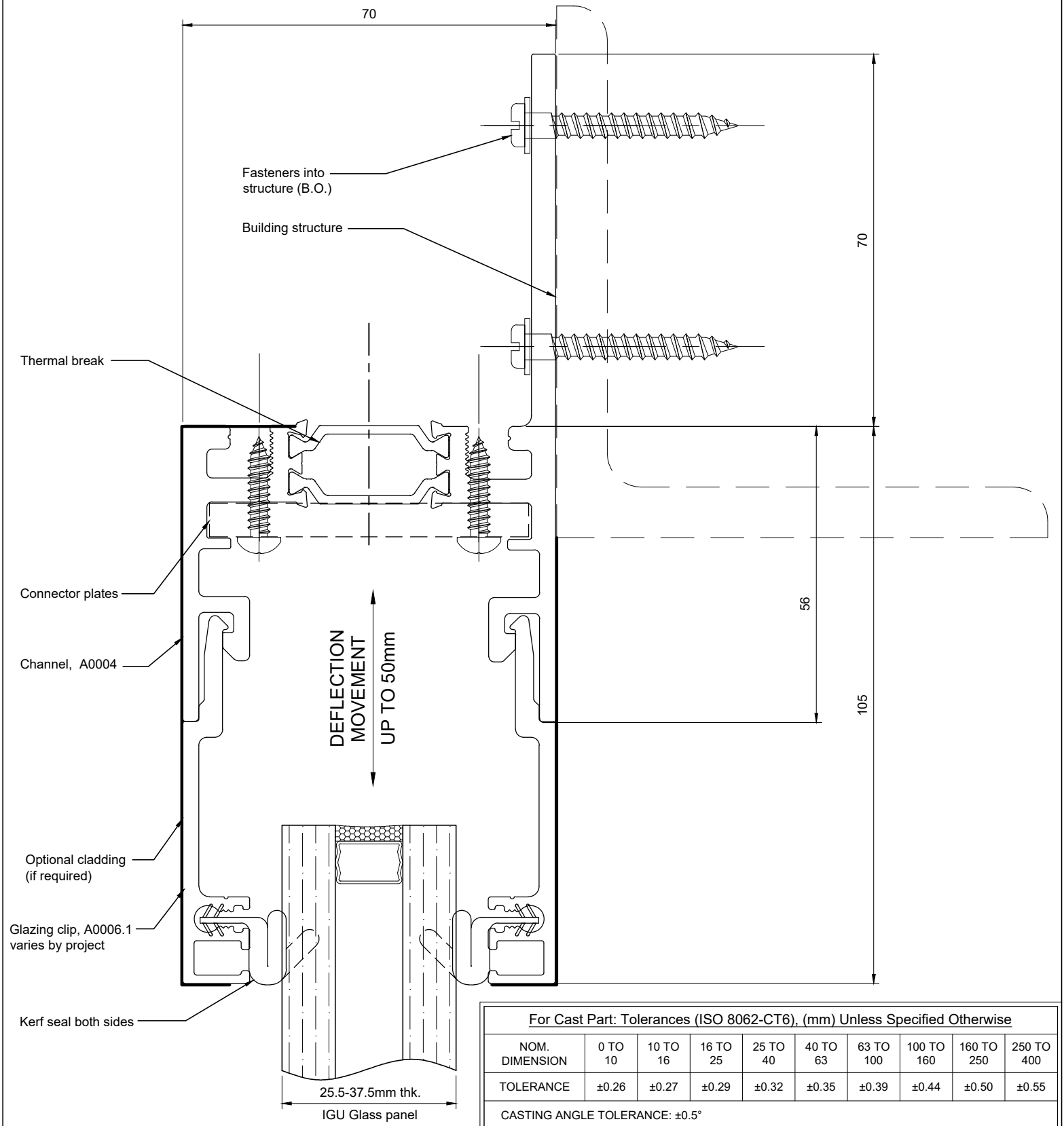

**SUBJECT TO CHANGE BY PROJECT**

**Notes:**  
1. Other finishes available upon request

CUSTOMER APPROVAL SIGNATURE:  
DATE:

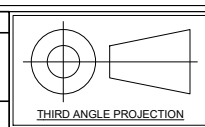

THERMALLY BROKEN PERIMETER CHANNELS  
for SEALED GLASS UNITS UP TO 37mm THICK  
HEAD DETAIL - FACE MOUNTED

SCALE  
1:1  
DWG No  
PC-3710TS-A02

UNIT 105-8218 NORTH FRASER WAY, BURNABY, BC, V3N 0E9  
TEL (604) 231 5892 [WWW.STELLAGLASSHARDWARE.COM](http://WWW.STELLAGLASSHARDWARE.COM)